

CI-5010A/CI-5200A/CI-5500A

Weighing Indicator

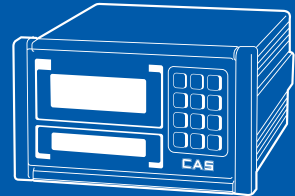

Table of Contents

1. Introduction	4
2. Features & Main function	6
3. Technical Specification	7
4. Measure of Appearance	9
5. Front Panel	10
6. Rear Panel	14
7. Installation & Connection	15
8. Serial Communication (RS-232C)	17
9. Test Mode	20
10. Calibration Mode	25
11. Set Mode	30
12. Weighing Mode	46
13. Options	52
14. Sealing Method	58
15. Error Message & Troubleshooting	59

1. Introduction



Thank you for purchasing the CAS CI-5000 Series weighing indicator. We have designed this equipment with many advanced features, high quality construction, and user-friendly menu driven programming. We are confident that you will find the CAS CI-5000 Series will meet all of your most demanding needs. CAS indicator is shaped firmly and delicately designed to coincide with the special requirements of several industrial fields and includes many functions and various external interfaces. Also, it contains help display functions to be used easily.

Before using CI-5000 Series, It is recommended to read this manual carefully and to apply the function application fully.

Precautions



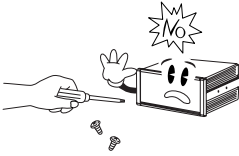
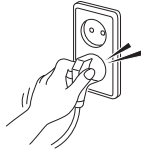

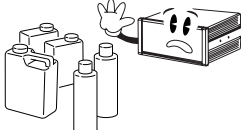
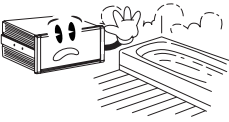
Observe the following safety precautions :

Warning

<p>When any damage or defect occurs, contact your CAS authorized dealer immediately for proper repair.</p>	<p>Insert plug firmly to wall outlet to prevent electric shock.</p>	<p>Scale must be grounded to minimize electricity static. This will minimize defect or electric shock.</p>
		
<p>Do not pull the plug by its cord when unplugging. Damaged cord could cause electric shock or fire.</p>	<p>To prevent from fire occurring, Do not place or use the scale near flammable or corrosive gas.</p>	<p>To reduce electric shock or incorrect reading, Do not spill water on the scale or place it in humid condition.</p>
		

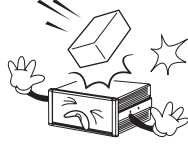
<p>Avoid placing the scale near heater or in direct sunlight.</p>	
	

! Attention

<p>For consistent and accurate reading, maintain periodical check by your CAS authorized dealer.</p>	<p>Avoid sudden shock to the scale. Internal mechanism could be damaged.</p>	<p>Attach the rubber pad to the bottom of the indicator. Elimination is possible.</p>
		
<p>Place the scale on firm and temperature consistent environment.</p>	<p>Keep the scale away from the electromagnetic generation devices. This may interfere with accurate reading.</p>	
		

Our Dealers : CAS feels that each of its valued customers should get the best service available. Whether it's the initial installation of our product, maintenance/repair work, or simply answering questions about our products, CAS Corporation and all of its Authorized Dealers are highly trained to assist you with any need regarding CAS products.

2. Features & Main Functions

1) Features

- High quality, high accuracy
- Appropriate for weight and measurement system
- Easy operation and various options
- Sub display of 12 digits(VFD) – **Only CI-5500A**
- RFI/EMI screened
- Watchdog circuitry (System restoration)
- Weight back up (Weight memory at sudden power failure)

2) Main Functions

- Saving of date, time and calculated data at sudden power failure
- Digital filter function
- Adjustable A/D conversion speed (10~50 times/sec)
- Various printer connection (serial, parallel)
- Serial interface (Standard : RS-232C, Option : RS-422/RS-485)
- PC communication (PC command mode)
- Set-point can save up to 50 batch operations
- Users can set the max. weight and a division freely
- External input 4 relay. (Refer to SET mode-F44)
- External output 4 relay (zero, high, low, final) – **Except CI-5010A**
- Print date and time by built-in clock
- Independent zero calibration
- Display the high limit and the low limit at the VFD screen – **Only CI-5500A**
- Saving of measured weighing times
- Self hardware test

3. Technical Specification

■ Analog Part & A/D Conversion

Load Cell Excitation Voltage	DC 10V, 8 x 350Ω load cells
Zero Adjustment Range	0.05mV ~ 20mV
Input Sensitivity	1.2μV/V
System Linearity	Within 0.01% of F.S.
A/D Internal Resolution	1 / 200,000
A/D External Resolution	10,000 dd (Max)
A/D Conversion Speed	Maximum 50 times/sec

■ Digital Part

Span Calibration	Full Digital Calibration : SPAC™ (Single automatic span calibration)
Display	VFD (7 digit) : 6.0(W) x 13.0(H) mm
Sub Display (CI-5500A)	VFD (12 digit) : 3.3(W) x 8.0(H) mm
Division	×1, ×2, ×5
Display Below Zero	Minus
Tare Subtraction	Full capacity

■ General Specification

Power	AC 110V/220V, 50/60 Hz
Product Size	195(W) x 192.7(D) x 98 (H)
Temperature Range	-10℃ ~ 40℃
Product Weight	Approx. 2.5 kg
Fuse Capacity	T250mA L250V
Power Consumption	Approx. 10W

■ Options

Option 1	RS-422/RS-485 serial interface
Option 2	BCD output
Option 3	Analog output(I-out : 0~24mA, V-out : 0~10V)

■ Accessories

Item	Qty	Specification
Owner's manual	1	CI-5010A/ CI-5200A/ CI-5500A
Power cord	1	Input : CEE 7/7, Output : IEC 60320 C13
Loadcell connector	1	Shield cable assembly (16N07R * 500mm)
Fuse	1	T250mA L250V
Rubber foot	4	
Sealing wire	1	100mm
Sealing solder	1	

4. Measure of Appearance

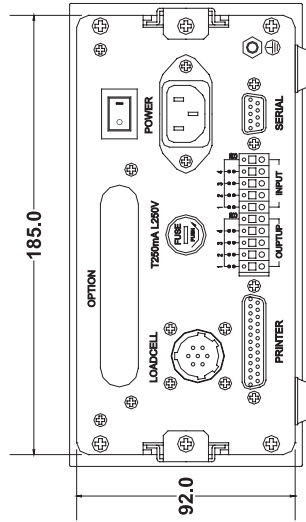
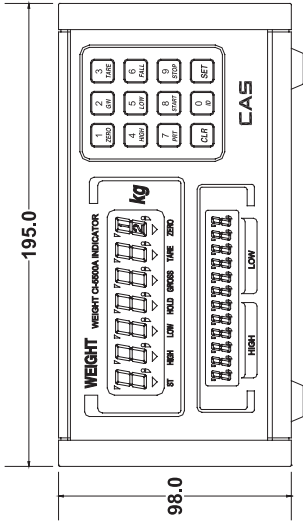
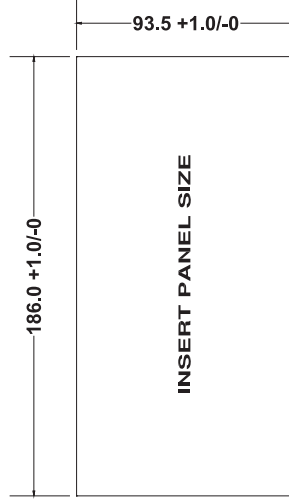
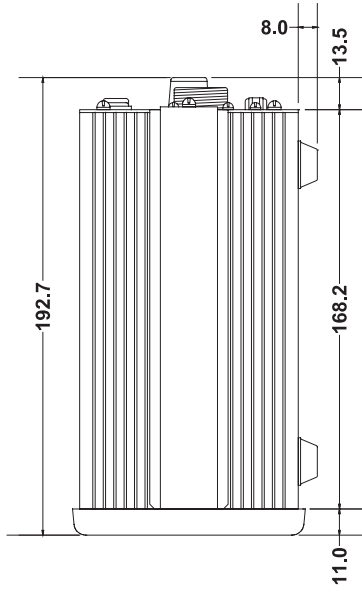

5. Front Panel

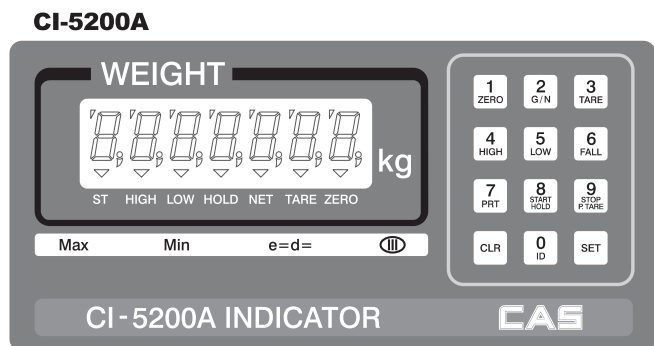
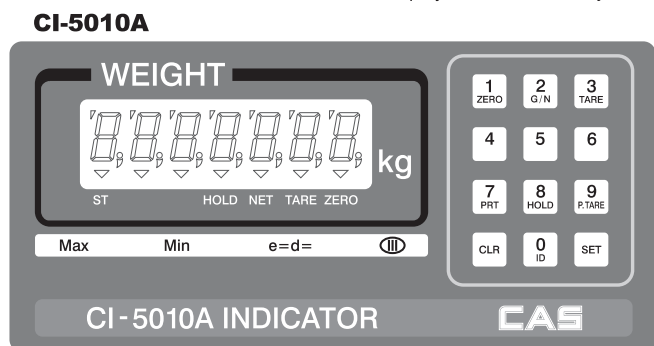
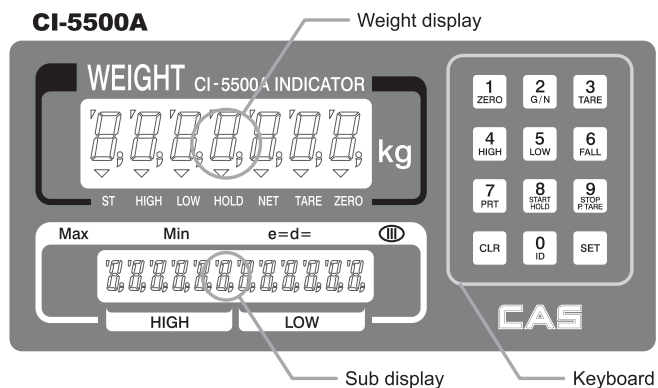

1) Weight display - Display lamp (▼)

STABLE lamp : lights up when the weight is stable.

HIGH lamp : lights up when the high limit relay is activated. (Except CI-5010A)

LOW lamp : lights up when the low limit relay is activated. (Except CI-5010A)

HOLD lamp : lights up when you press HOLD key.

NET lamp : lights up when the display shows net weight.

TARE lamp : lights up when tare weight is stored.

ZERO lamp : lights up when current weight is 0 kg.

2) Sub display (CI-5500A)

HIGH : It shows the high limit.

LOW : It shows the low limit.

3) Keyboard

■ Key

Used to remove small variations in the indicator's zero.

(user can set the zero range within $\pm 2\%$ or $\pm 10\%$ of the maximum capacity, see F09 at page 34).

Used to go to the "TEST" mode.

■ Key

Toggles the display between gross weight and net weight.

If tare weight is saved, tare plus item's weight is gross weight and only item's weight is net weight. Used to go to the "SET" mode.

■ Key (Weighed tare entry)

Used to weigh an item by using the container.

When this key is pressed, the scale stores current weight as the tare weight.

If you press  key in unload condition, tare weight is released.

Used to enter the "CAL" mode.



■ Key (Except CI-5010A)

Used to see the high limit on the display, or change the high limit.

■ Key (Except CI-5010A)



Used to see the low limit on the display, or change the low limit.



■  Key (Except CI-5010A)

By pressing the  key and then  or  key, high fall limit or low fall limit is shown on the display.



■  Key

Manual Print Key. Designated printing form is printed.
Set print format in SET mode. (See F31 at page 37)

■  or  Key

Key	Model	Description
	CI-5010A	Used to weigh live animals or an unstable items. (Used as HOLD key)
	CI-5200A CI-5500A	F12 - 0 : Used as START key in packer mode. F12 - 1 : Used to weigh live animals or an unstable item.

■  or  Key

Key	Model	Description
	CI-5010A	Manual tare entry. If the tare weight is previously known press this key, and enter the tare weight by using the numeric keys, and then press SET key register it. (Used as MANUAL TARE key).
	CI-5200A CI-5500A	F12 - 0 : Used as STOP key in packer mode. F12 - 1 : Manual tare entry. If the tare weight is previously known press this key, and enter the tare weight by using the numeric keys, and then press SET key register it. (Used as MANUAL TARE key).

■  Key

Use (1) : Press "ID" key and type the ID code by pressing the numeric keys and then the ID code is registered. Range of the ID code is 0 to 50.

Use (2) : Clear set-point by pressing this key for 2 seconds.



■  Key

Use (1): Used to clear erroneous entries.

Use (2): Used to enter decimal point.

-  Key

Used to save current condition and exit in Calibration, Test, Set mode.

-  ~  Key

Numeric Keys. Used to enter setting value, tare, ID code, etc.

6. Rear Panel

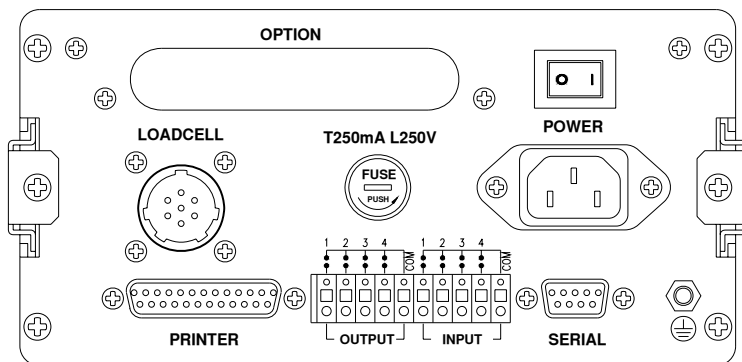

- **PRINTER** : Parallel interface port
- **INPUT** : External input (Refer to SET mode F44)
 OUTPUT : External output (ZERO, HIGH, LOW, FINAL) - **Except CI-5010A**
- **SERIAL** : Serial interface port (Standard : RS-232C, Option : RS-422/RS-485)
- **FUSE** : 250mA 250V fuse.
- **LOAD CELL** : Port for connecting load cell.
- **OPTION** : BCD output, Analog output (0-24mA or 0-10V)
- **POWER** : Power ON/OFF

7. Installation & Connection

1) Load cell connection

Connect load cell connector to load cell port which is in the backside of the indicator.

* Connecting method

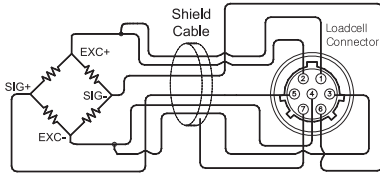

PIN	COLOR
1 (EXC+)	RED
3 (EXC-)	WHITE
5 (SIG+)	GREEN
6 (SIG-)	BLUE
7 (SHIELD)	SHIELD

Note. Wire color can be different depending on the loadcell's manufacturer or it's model.

* Load cell output to Resolution

10V impression to loadcell Max. load cell output	Recommended resolution
4 mV	1/4,000
8 mV	1/8,000
10 mV	1/10,000

2) External input/output port connection

Multi Connector	RELAY	
1	ZERO RELAY	RELAY OUTPUT (Except CI-5010A)
2	LOW RELAY	
3	HIGH RELAY	
4	FINAL RELAY	
COM	RELAY OUTPUT COM	
1	ZERO/TARE RELEASE/GROSS KEY	KEY INPUT Refer to F44 at page 43.
2	TARE/PRINT/NET KEY	
3	GROSS/PRINT/HOLD/START KEY	
4	GROSS/NET,GROSS/HOLD RELEASE /STOP KEY	
COM	KEY INPUT COM	

Input circuit

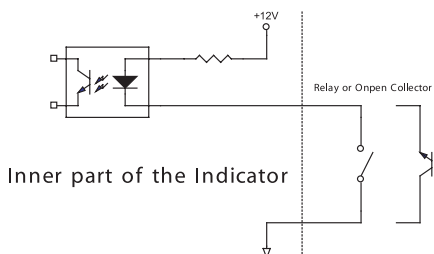

Output circuit

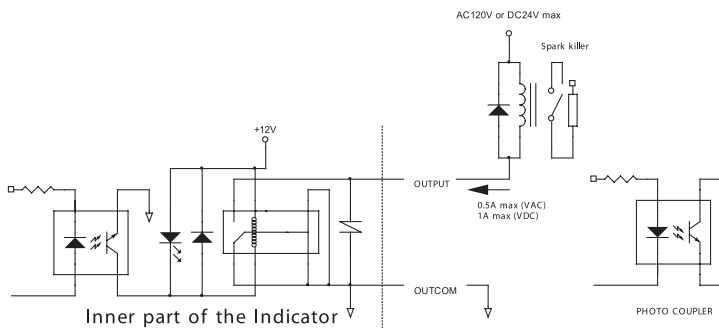

8. Serial Communication (RS-232C)

1) RS232C connection

① How to Connect PC

Connect the serial port on the rear panel of the indicator to serial port of PC as follows.

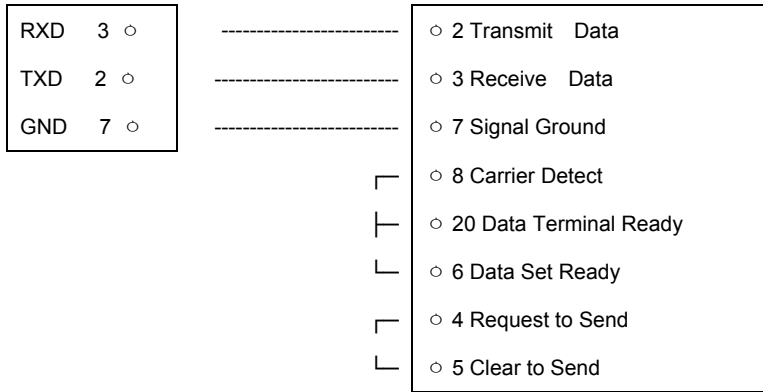

9 pin port(Male)
RS-232C port of CI-5000 Series

25 pin port(Female)
Serial port of computer

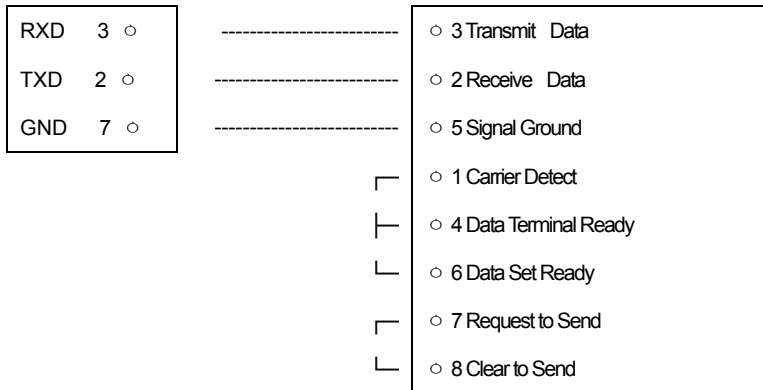

9 pin port(Male)
RS-232C port of CI-5000 Series

9 pin port(Female)
Serial port of computer

② How to Connect Sub Display (CD-Series)

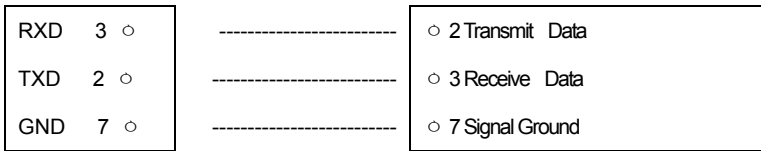

9 pin port(Male)
RS-232C port of CI-5000 Series

9 pin port(Male)
RS-232C port of sub-display

2) Data format

- ① Baud rate : 1200 bps - 19200 bps
Set Baud rate in SET mode. (See F20 at page 35.)
- ② Data bit: 8, Stop bit: 1, Parity bit: None
Data bit: 7, Stop bit: 1, Parity bit: Even/odd
- ③ Code : ASCII
- ④ When data is sent to computer?
Set in SET mode(See F22 at page 36.)
- ⑤ Format
* 22 byte of CAS



US(Unstable) GS(GROSS weight) Device ID Lamp condition byte Empty Unit (kg/t)
ST(Stable) NT(NET weight)
OL(Overload)

- Device ID : Transmit 1 byte so that the receiver can receive data selectively which indicator sent.(Device ID is selected in F23 .)
- Lamp condition byte

Bit 7	Bit 6	Bit 5	Bit 4	Bit 3	Bit 2	Bit 1	Bit 0
1	Stable	High	Low	Hold	Net	Tare	Zero

When the lamp is on, it has the output 0. When the lamp is off, it has the output 1.

* Weight Data (8 byte)

- a. 13.5kg : ',' ',' ',' ',' ',' '1', '3', ',' ',' '5'
- b. 135kg : ',' ',' ',' ',' ',' '1', '3', '5', ',' '
- c. -135kg : '-', ',' ',' ',' ',' '1', '3', '5', ',' '

3) Command mode (F22-3 command mode)

Command	Function	Response
dd RW CR LF	Reads the weight	If dd RW CR LF is received, the indicator will send the 22byte.
dd MZ CR LF	Same as ZERO key	If dd MZ CR LF is received, the display shows ZERO and dd MZ CR LF will be sent to PC.
dd MT CR LF	Same as TARE key	If dd MT CR LF is received, tare is activated so ZERO, TARE lamp is on and dd MT CR LF will be sent to PC.
dd HI 00000 CR LF	Enter high limit value (Except CI-5010A)	Change the high limit value to 00000 (no decimal point) and dd HI 00000 CR LF will be sent to PC.
dd LO 00000 CR LF	Enter low limit value (Except CI-5010A)	Change the lower limit value to 00000 (no decimal point) and dd LO 00000 CR LF will be sent to PC.
dd HE 00000 CR LF	Enter high fall value (Except CI-5010A)	Change the high fall value to 00000 (no decimal points) and dd HE 00000 CR LF will be sent to PC.
dd LE 00000 CR LF	Enter high fall value (Except CI-5010A)	Change the low fall value to 00000 (no decimal point) and dd LE 00000 CR LF will be sent to PC.
dd PN 00 CR LF	Enter ID(00~50)	Change the ID and dd PN 00 CR LF will be sent to PC.
dd OP CR LF	Use as START key (Except CI-5010A)	If dd OP CR LF is received, the indicator will start in packer mode and dd OP CR LF will be sent to PC. (You have to set F40 to Packer mode)
dd EM CR LF	Use as STOP key (Except CI-5010A)	If dd EM CR LF is received, the indicator will stop in packer mode and dd EM CR LF will be sent to PC. (You have to set F40 to Packer mode)

↳ dd : Device number

↳ 00000 : High limit value / low limit value/ high fall value/ high fall value
(If the setting value is "00345", ASCII CODE is 0×30(hex), 0×30(hex), 0×33(hex), 0×34(hex), 0×35(hex))

* If the command is not accepted for any reason, I CR LF will be sent to PC.

* If an invalid character is received, ? CR LF will be sent to PC.

* If F30 is set to 4, do not transmit weight data.

9. Test Mode

1) How to enter test mode

Turn on the power while pressing the  key.

2) Test menu (TEST 1~9)

TEST 1 : Key test

TEST 2 : VF Display test

TEST 3 : Load cell test and A/D conversion test

TEST 4 : Serial interface test

TEST 5 : Printer test

TEST 6 : SRAM test

TEST 7 : External input/output test

TEST 8 : BCD output test

TEST 9 : Analog output test

TEST 1

FUNCTION : Key test			
KEY	VF DISPLAY	SUB DISPLAY	DESCRIPTION
 : Menu selection mode Other keys: Perform test	1 1	tESt KEY	Press any key to test then the display shows its number and code.

< Key list >

KEY	NO	CODE	KEY	NO	CODE	KEY	NO	CODE
	1	1		6	6		0	12
	2	0		7	9		70	99
	3	2		8	8			
	4	5		9	10			
	5	4		11	13			

TEST 2

FUNCTION : VF Display test			
KEY	VF DISPLAY	SUB DISPLAY	DESCRIPTION
: Menu selection mode Other keys: Perform test	8.8.8.8.8.8.8. ▼▼▼▼▼▼▼▼	tESt2 VFd 888888888888	TEST 2 is performed.

TEST 3

FUNCTION : Load cell test and A/D conversion test			
KEY	VF DISPLAY	SUB DISPLAY	DESCRIPTION
: Menu selection mode	5500	tESt3 AnALoG	The display shows digital value of current weight. This value means converted digital value.

Note 1. Check whether the digital value is changing whenever you load or unload the weight on the platter. If the digital value is fixed or zero is displayed, please check the connection of loadcell.

TEST 4

FUNCTION : Serial interface test			
KEY	VF DISPLAY	SUB DISPLAY	DESCRIPTION
 : Menu selection mode Other keys: Perform test	----- ----- 05 13--- 05	tEST4 SERIAL	Waiting for transmission or reception. Transmit : 5, Receive: none Transmit: 5, Receive: 13

Note 1. Before testing, you have to connect serial port of computer with serial port of indicator and run the communication program such as Hyper Terminal in PC.

Note 2. Send no.1 in PC keyboard and check if indicator receives no.1

Send no.1 in indicator keyboard and check if PC receives no.1

Note 3. Do this test after baud rate is specified in SET mode. (See F20 at page 35.)

TEST 5

FUNCTION : Printer test			
KEY	VF DISPLAY	SUB DISPLAY	DESCRIPTION
 : Menu selection mode Other keys: Perform test	Good CH 05	tEST5 Print	No error in printer. Check printer connector.

Note 1. Previously specify the printer which will be used in the conversion mode.(F30)

Note 2. "Good" message is displayed if the printer connection and specification is done' correctly.

If not, CH 05 message is displayed.

Note 3. Test format of printing is as follows.

Computer And System
 CAS Corporation
 http : //www.cas.co.kr
 TEL 82-2-2225-3500
 FAX 82-2-475-4669
 TEST OK

TEST 6

FUNCTION : SRAM test			
KEY	VF DISPLAY	SUB DISPLAY	DESCRIPTION
[SET] : Menu selection mode Other keys: Perform test	Good	tESt6 rAM	SRAM is in normal state.

TEST 7



FUNCTION : External input/output test			
KEY	VF DISPLAY	SUB DISPLAY	DESCRIPTION
[SET] : Menu selection mode External input : External key External output Perform test : [1 ZERO] [2 G/N] [3 TARE] [4 HIGH]	In1oUt3	tESt7 rELAY	In1 : If you press 1 by using external key, and no.1 is entered. oUt3 : A state of external output It means output no. 3 is on.

Note 1. In case of CI-5010A, only external input is possible.

TEST 8

FUNCTION : BCD output test			
KEY	VF DISPLAY	SUB DISPLAY	DESCRIPTION
[SET] : Menu selection mode	oFF	tESt8 bCdoUt	oFF : Turn off BCD output
[CLR] : Toggles between on and off	on		on : Turn on BCD output

TEST 9

FUNCTION : Analog output test(0-24mA, 0-10V)			
KEY	VF DISPLAY	SUB DISPLAY	DESCRIPTION
 : Menu selection mode	HGH	tEST9 AdoUt	HIGH : Output of maximum weight
 : Toggles between high and zero	ZEro		ZEro : Output of zero value

10. Calibration Mode

1) How to enter calibration mode

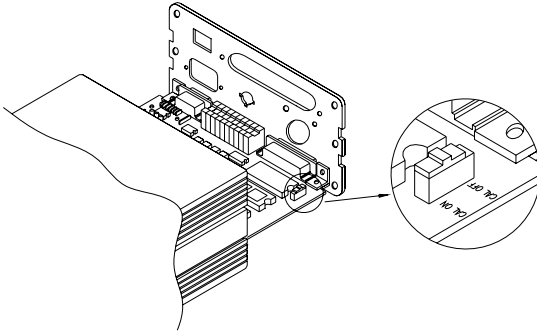

- ① Remove the bolt on the rear panel and put the switch to CAL ON as figure.
※ Adjusted to CAL ON at factory.
- ② Turn on the power while pressing the .
- ③ Calibrate the scale.
- ④ Put the switch to CAL OFF and perform the sealing. (See page 58)

2) Calibration menu(CAL1~CAL7)

- CAL 1 : Maximum capacity set
- CAL 2 : Minimum division Set
- CAL 3 : Setting Weight In Span Calibration
- CAL 4 : Zero calibration
- CAL 5 : Span calibration
- CAL 6 : Check if the calibration is done properly
- CAL 7 : Weight constant calibration

CAL 1 (press '1' key to move to CAL 1)

FUNCTION : Maximum Capacity Set (range : 1 ~ 99,999)			
KEY	VF DISPLAY	SUB DISPLAY	DESCRIPTION
[SET] : save and go to next menu [0] ~ [9] : set value change [CLR] : exit	C = 5000 C = 20000	CAL1 CAPA	5000 kg 20000 kg

Note 1. Maximum capacity means the maximum weight that the scale can measure.

CAL 2

FUNCTION : Minimum Division Set (Range : 0.001 ~ 500)			
KEY	VF DISPLAY	SUB DISPLAY	DESCRIPTION
[SET] : save and go to next menu [0] ~ [9] : set value change [CLR] : input the point	d = 1 d = 0.2 d = 0.05 d = 0.001	CAL2 dIVI	1 kg 0.2 kg 0.05 kg 0.001 kg

Note 1. The minimum division means the value of one division.

Note 2. External resolution is obtained by dividing the maximum capacity into the min. division.

Set the resolution to be within 1/10,000.

Note 3. When you press other keys except '1', '2', '5' and '0', you will hear error beep.

CAL 3

FUNCTION : Setting Weight In Span CALIBRATION			
KEY	VF DISPLAY	SUB DISPLAY	DESCRIPTION
[SET] : save and go to next menu [0] ~ [9] : set value change [CLR] : input the point	L = 5000 L = 500	CAL3 SPAn	5000 kg 500 kg

Note 1. The setting weight should be within the 10 % to 100 % of maximum weight.

Note 2. If the setting weight is under the 10% of the maximum capacity, the display shows error message, CH 12.

Note 3. If the setting weight is over the maximum capacity, the display shows error message, CH 12.

CAL 4

FUNCTION : Zero Calibration			
KEY	VF DISPLAY	SUB DISPLAY	DESCRIPTION
[SET] : zero calibration. [CLR] : exit	UnLoAd ---- SUCCESS	CAL4 ZERo	Unload the tray and press SET under zero calibration. Zero calibration is completed. The program moves into Span calibration automatically.

Note 1. If Zero calibration is done without any error, SUCCESS message is displayed and program moves into CAL 5 automatically.

Note 2. If the zero value is too low/high check message CH 14 is displayed.

Note 3. Zero calibration can be done independently, Pressing [1 ZERO] key instead of [CLR] will perform this function.

CAL 5

FUNCTION : Span Calibration			
KEY	VF DISPLAY	SUB DISPLAY	DESCRIPTION
<input type="button" value="SET"/> : span calibration <input type="button" value="CLR"/> : exit	UP ---- SUCCESS	CAL5 LoAd	Load the weight which was set in CAL 3 and press SET key. Under span calibration... Span calibration is completed. Check whether the displayed weight is same with setting weight.

Note 1. If Span calibration is done without any error, SUCCESS message is displayed.

The weight of setting weight is displayed on VFD screen. Check the weight.

Note 2. If the span is low, Error message CH 13 is displayed. In that case, Calibrate with lower resolution. Please check the span value to be resolution $\times 20$ in TEST 3.

CAL 6

FUNCTION : Check if the calibration is done properly			
KEY	VF DISPLAY	SUB DISPLAY	DESCRIPTION
<input type="button" value="SET"/> : save and go to next menu <input type="button" value="CLR"/> : exit from the CAL mode	5000kg ▼▼▼▼▼▼▼▼	CAL6 VERiFY	5000 kg

Note 1. If the central lamp lights up as above VF Display, the bias is "0", and each lamp indicates the bias of -3, -2, -1, 0, 1, 2, 3 from the left lamp.

Note 2. Confirm if the displayed weight is equal to the setting weight you entered in CAL3,

and press the key 2 times to go to weighing mode.

CAL 7

FUNCTION : Input weight constant calibration after selecting national code			
KEY	VF DISPLAY	SUB DISPLAY	DESCRIPTION
<p> <input type="text" value="0"/> ~ <input type="text" value="9"/> : enter password <input type="text" value="CLR"/> & <input type="text" value="SET"/> : finish the CAL mode </p>	<p>FACTOr</p>	<p>CAL7 FACTor</p>	<p>Type the password.</p>

Note 1. Users do not have to use this menu, since it is used for calibration test without a weight.

Note 2. If you press the key two times, the display shows CAL End and then you can go to weighing mode.

11. Set Mode

1) How to enter set mode

Turn on the power while pressing the $\boxed{2}_{G/N}$ key.

In weighing mode, press the $\boxed{2}_{G/N}$ key for 3 seconds to move to this mode.

2) Available keys

$\boxed{0}$ ~ $\boxed{9}$ key : used for changing preset value.

\boxed{SET} key : Used to save changed setting value and go to menu selection mode.

\boxed{CLR} key: Used to go to menu selection mode without saving.

* Used to toggle between on and off in SET 07,10,33.

3) Set menu (F01~F49)

General setting	
F01 Date	Year, month, day
F02 Time	Hour, minute, second
F03 Display conversion speed	10 ~ 50 times/sec.
F04 Digital filter	1 ~ 50 digit average
F05 Stable condition	1 ~ 9
F06 Automatic zero condition	00 ~ 99
F07 Weight backup	OFF / ON
F08 Hold type	0 / 1 (average hold / peak hold / sampling hold)
F09 Operation range of $\boxed{1}_{ZERO}$ key	0 / 1 ($\pm 2\%$ / $\pm 10\%$)
F10 Conditions of $\boxed{1}_{ZERO}$ and $\boxed{3}_{TARE}$ key	OFF / ON (stable/unstable)
F11 Load cell type	0 / 1 (compression or tension/ compression and tension)
F12 $\boxed{8}_{START HOLD}$ and $\boxed{9}_{STOP P. TARE}$ key set	0 / 1 (start, stop / hold, manual tare)

Serial interface	
F20 Baud rate	1200, 2400, 4800, 9600, 19200bps
F21 Parity bit	0 ~ 2 (non parity / even / odd)
F22 Transmission method	0 ~ 5
F23 Device number	00 ~ 99

Print	
F30 Set printer	0 ~ 4
F31 Set print format	7 kinds of print form
F32 Set manual / automatic print	0 / 1 (manual / automatic)
F33 Initialization of weighing number and accumulated data	OFF / ON
F34 Input user's print message	0 ~ 71 character
F35 Line feed	1 ~ 9 line feed

External input/output	
F40 Relay mode	0 ~ 4
F41 Timer - start delay of finish signal	0.0 ~ 9.9 (0.0sec ~ 9.9sec)
F42 Timer - end delay of finish signal	0.0 ~ 9.9 (0.0sec ~ 9.9sec)
F43 Range of zero relay	00 ~ 99 digit
F44 External input	0 ~ 6
F45 Option selection	0 ~ 2 (none / BCD output / Analog output)
F46 Output current at zero	00000 ~ 24000 (00.000mA ~ 24.000mA)
F47 Output current at maximum capacity of the scale	00000 ~ 24000 (00.000mA ~ 24.000mA)
F48 Analog output data	0 / 1 (Net / Gross)
F49 Logic of BCD output	0 / 1 (Positive / Negative logic)

* Note : In case of CI-5010A, F12, F40~F43 are not available.

① General setting

F01

FUNCTION : Change of year, month, day			
	VF DISPLAY	SUB DISPLAY	DESCRIPTION
Set value	98.03.02	F01 dAtE	March 2nd, 1998
	00.12.10		December 10th, 2000

Note 1. Modify the year, month and date by pressing the ~ key.

F02

FUNCTION : Time adjustment			
	VF DISPLAY	SUB DISPLAY	DESCRIPTION
Set value	00.30.01	F02 tmE	Twelve thirty and one second, A.M.
	22.20.00		Exact time of ten twenty, P.M

Note 1. Modify the time by pressing the ~ key

F03

FUNCTION : Display conversion speed			
	VF DISPLAY	SUB DISPLAY	DESCRIPTION
Set value (10~50)	10	F03 SPEEd	10 times/sec. (low speed)
	20		20 times/sec. (normal speed)
	50		50 times/sec. (high speed)

F04

FUNCTION : Digital filter (Speed control of weight display)			
	VF DISPLAY	SUB DISPLAY	DESCRIPTION
Set value (1~9)	1	F04 FILTEr	1 time average value
	5		5 times average value
	9		9 times average value

Note 1. You have to set display conversion speed in F03, before you set F04.

F05

FUNCTION : Stable condition of weight			
	VF DISPLAY	SUB DISPLAY	DESCRIPTION
Set value (1~9)	1	F05 StAbLE	Stable lamp is off even with the change of only one division.
	2		Stable lamp is on if the weight is changed within two division.
	9		Stable lamp is on if the weight is changed within nine division.

F06

FUNCTION : Automatic zero condition			
	VF DISPLAY	SUB DISPLAY	DESCRIPTION
Set value (00~99)	00	F06 AZero	No compensation
	11		Compensation for gradual change below 0.5 division for 1 sec.
	99		Compensation for gradual change below 4.5 division for 9 sec.

Note 1. To have division, divide the first number on the VF Display by 2.

Note 2. The second number indicates a second on the VF Display..

F07

FUNCTION : Weight backup			
	VF DISPLAY	SUB DISPLAY	DESCRIPTION
Set value (oFF, on)	oFF	F07 bACKUP	Weight backup is off
	on		Weight backup is on

Note 1. If weight backup is on, the scale saves previous weight when power failure is occurred.

Note 2. On and Off are alternately displayed by pressing the  key.



F08

FUNCTION : Hold type			
Set value (0, 1)	VF DISPLAY	SUB DISPLAY	DESCRIPTION
	0	F08 HoLd	Average Hold
	1		Peak Hold

F09

FUNCTION : Operation range of  key			
Set value (0, 1)	VF DISPLAY	SUB DISPLAY	DESCRIPTION
	0	F09 rAnGE	$\pm 2\%$: zero key is operated within $\pm 2\%$ of maximum weight
	1		$\pm 10\%$: zero key is operated within $\pm 10\%$ of maximum weight

F10



FUNCTION : Conditions of  and  key (stable/unstable)			
Set value (oFF, on)	VF DISPLAY	SUB DISPLAY	DESCRIPTION
	oFF	F10 Zt-C	Zero, Tare key is operated when the scale is stable.
	on		Always

Note 1. On and Off are alternately displayed by pressing the  key.

F11

FUNCTION : Load cell type			
Set value (0, 1)	VF DISPLAY	SUB DISPLAY	DESCRIPTION
	0	F11 L-tyPE	Compression or tension load cell
	1		Compression and tension load cell

F12 (Except CI-5010A)

FUNCTION : A use of  and  key			
Set value	VF DISPLAY	SUB DISPLAY	DESCRIPTION
(0, 1)	0	F12 8-9KEY	START / STOP key
	1		HOLD / MANUAL TARE key

② Serial interface function

F20

FUNCTION : Baud rate			
Set value	VF DISPLAY	SUB DISPLAY	DESCRIPTION
(0 ~ 4)	0	F20 bAUd	1200bps
	1		2400bps
	2		4800bps
	3		9600bps
	4		19200bps

F21

FUNCTION : Parity bit			
Set value	VF DISPLAY	SUB DISPLAY	DESCRIPTION
(0 ~ 2)	0	F21 PARty	Data bit 8, stop bit 1, none parity
	1		Data bit 7, stop bit 1, even parity
	2		Data bit 7, stop bit 1, odd parity

F22

FUNCTION : Data transmission			
	VF DISPLAY	SUB DISPLAY	DESCRIPTION
Set value (0 ~ 4)	0	F22 SEND	No data transmission
	1		Transmit data in a state of stable & unstable
	2		Transmit data only in stable state
	3		Transmit data only in command mode
	4		Transmit data if you press PRINT key(PRT)
	5		Transmit weight data during inputing device No.

Note 1. The default value is set to 0 at factory.

Note 2. If F30 is set to 4, do not transmit weight data.

Note 3. When F22 is set to 3, refer to command mode at page 19.

F23

FUNCTION : Device ID (Identification of each indicator)			
	VF DISPLAY	SUB DISPLAY	DESCRIPTION
Set value (00 ~ 99)	00	F23 dEVICE	Device No. 00
	05		Device No. 05

③ Print function

F30

FUNCTION : Printer			
	VF DISPLAY	SUB DISPLAY	DESCRIPTION
Set value (0 ~ 4)	0	F30 Print	Printer is not used
	1		EPSON printer
	2		FS-7000D, 7040P parallel version
	3		EPSON printer (LQ-550H,LQ1550H etc)
	4		Serial printer

F31

FUNCTION : Print Form			
	VF DISPLAY	SUB DISPLAY	DESCRIPTION
Set value (0~6)	0	F31 P-Form	0 (date, time, serial No., ID No., net weight)
	1		1 (date, time, weigh No., net weight)
	2		2 (date, time, gross, tare, net weight)
	3		3 (date, time, net weight)
	4		4 (date, time, ID No., net weight)
	5		5 (date, time, serial No., net weight)
	6		6 (net weight)

Note 1. Serial No. is available 1 to 999 and initialized to 1 after “GRAND TOTAL” printing or power-off.

Note 2. Weigh No. is available 1 to 999 and is not initialized to 1 after power-off.

If you want to initialize it, set F33 to ON in SET mode.

【 Form 0 】

Date, Time
Serial No., ID No., Net weight

2002. 1. 1	12:30
001, ID_11	50.0 kg
002, ID_12,	100.0 kg
003, ID_19,	200.5 kg

【 Form 1 】

Date, Time
Weigh No., Net weight

2002. 1. 1	12:30
No.10	50.0 kg
No.11	100.0 kg
No.12	200.5 kg

【 Form 2 】

Date, Time
Gross, Tare, Net weight

2002. 1. 1	12:30
Gross :	1000.0 kg
Tare :	0.0 kg
Net :	1000.0 kg

【 Form 3 】

Date, Time
Time., Net weight

2002. 1. 1	12:30
10:10	Net : 50.0 kg
11:00	Net : 100.0 kg
12:30	Net : 200.5 kg

【 Form 4 】

Date, Time
ID No., Net weight

2002. 1. 1	12:30
ID_11, Net :	50.0 kg
ID_12, Net :,	100.0 kg
ID_19, Net :	200.5 kg

【 Form 5 】

Date, Time
Serial No., Net weight

2002. 1. 1	12:30
001,	1000.0 kg
2002. 1. 1	12:50
002,	200.5 kg

【 Form 6 】

Net weight

50.0 kg
100.0 kg
200.5 kg

F32

FUNCTION : Manual / Automatic print			
Set value	VF DISPLAY	SUB DISPLAY	DESCRIPTION
(0, 1)	0	F32APrint	Manual print
	1		Automatic print

Note 1. Automatic print means that printing is performed without pressing the  key when the weight is in stable state.

F33

FUNCTION : Initialization of measured weighing number			
Set value	VF DISPLAY	SUB DISPLAY	DESCRIPTION
(oFF, on)	oFF	F33 InItIAL	Maintain current number
	on		Initialization (starting from No.1)

Note 1. On and Off are alternately displayed by pressing the  key.

F34

FUNCTION : Input user's print message				
<div style="border: 1px solid black; padding: 2px; display: inline-block;">CLR</div> key :increase coordinates <div style="border: 1px solid black; padding: 2px; display: inline-block; margin-right: 5px;">0</div> ~ <div style="border: 1px solid black; padding: 2px; display: inline-block; margin-right: 5px;">9</div> :enter code number	VF DISPLAY	SUB DISPLAY	DESCRIPTION	
		P12-065	F34 ASCII	Designate 'A' (ASCII code 65) in 12 th data
		P00-032		Set blank to 0th character to print message. This 32th code is essential to head message
	P18-255	Set 255 to 18th character. This code indicates the end of message to be printed		

Note 1. You can add information such as company name and phone no. in printing format.

Note 2. The range of coordinate is from 0 to 71. 0th code determines whether head message is printed or not.(032 : print, others : Do not print) Actually 1st data to 255 is printed.

Note 3. Designate as follows if you want to add company name "CAS" on print format.

P00-032(ASCII code 32 : Data start), P01-067(ASCII code 67 : character C)

P02-065(ASCII code 65 : character A),P03-083(ASCII CODE 83 :character S)

P04-255(ASCII code 255: Data end)

Note 4. ASCII code table

CHA	CODE	CHA	CODE	CHA	CODE	CHA	CODE	CHA	CODE	CHA	CODE
SPACE	32	0	48	@	64	P	80	`	96	p	112
!	33	1	49	A	65	Q	81	a	97	q	113
"	34	2	50	B	66	R	82	b	98	r	114
#	35	3	51	C	67	S	83	c	99	s	115
\$	36	4	52	D	68	T	84	d	100	t	116
%	37	5	53	E	69	U	85	e	101	u	117
&	38	6	54	F	70	V	86	f	102	v	118
'	39	7	55	G	71	W	87	g	103	w	119
(40	8	56	H	72	X	88	h	104	x	120
)	41	9	57	I	73	Y	89	i	105	y	121
*	42	:	58	J	74	Z	90	j	106	z	122
+	43	;	59	K	75	[91	k	107	{	123
,	44	<	60	L	76	\	92	l	108		124
-	45	=	61	M	77]	93	m	109	}	125
.	46	>	62	N	78	^	94	n	110	~	126
/	47	?	63	O	79	_	95	o	111	END	255

F35

FUNCTION : Line feed of paper			
	VF DISPLAY	SUB DISPLAY	DESCRIPTION
Set value (1~9)	1	F35 FEEd	1 line feed
	5		5 line feed
	9		9 line feed

④ External input/output function

F40 (Except CI-5010A)

FUNCTION : Relay mode			
	VF DISPLAY	SUB DISPLAY	DESCRIPTION
Set value (0~4)	0	F40 rELAY	Limit Mode
	1		Checker Mode
	2		Limit Type Checker Mode
	3		Packer Mode
	4		Relay is not used

<Limit Mode>

WEIGHT RELAY	(LOW LIMIT) (HIGH LIMIT)			
	0 kg	50 kg	100 kg	
ZERO (OUT RELAY 1)				ON OFF
LOW (OUT RELAY 2)				ON OFF
HIGH (OUT RELAY 3)				ON OFF
FINAL (OUT RELAY 4)				ON OFF

Note 1. When the scale is stable over the high limit, Final relay is **ON**.

Note 2. When low fall limit and high fall limit are set,
 Low limit relay is **ON** (Weight = Low limit - Low fall limit).
 High limit relay is **ON** (Weight = High limit - High fall limit).
 Note 3. Zero relay is **ON** depending on the set of F43 (see page 43.)

< Checker Mode >

WEIGHT RELAY	(LOW LIMIT) (HIGH LIMIT)			
	0 kg	50 kg	100 kg	
ZERO (OUT RELAY 1)				ON OFF
LOW (OUT RELAY 2)				ON OFF
HIGH (OUT RELAY 3)				ON OFF
FINAL (OUT RELAY 4)				ON OFF

Note 1. When the scale is stable, LOW, HIGH and FINAL relays are ON after passing the certain time of start delay and then Off after passing the certain time of end delay.
 Start delay time of finish relay is set in F41 and end delay time of finish relay is set in F42.

Note 2. Zero relay is **ON** depending on the set of F43 (see page 43.)

< Limit Type Checker Mode >

WEIGHT RELAY	(LOW LIMIT) (HIGH LIMIT)			
	0 kg	50 kg	100 kg	
ZERO (OUT RELAY 1)				ON OFF
LOW (OUT RELAY 2)				ON OFF
HIGH (OUT RELAY 3)				ON OFF
FINAL (OUT RELAY 4)				ON OFF

Note 1. Zero relay is **ON** depending on the set of F43 (see page 43.)

< Packer Mode >

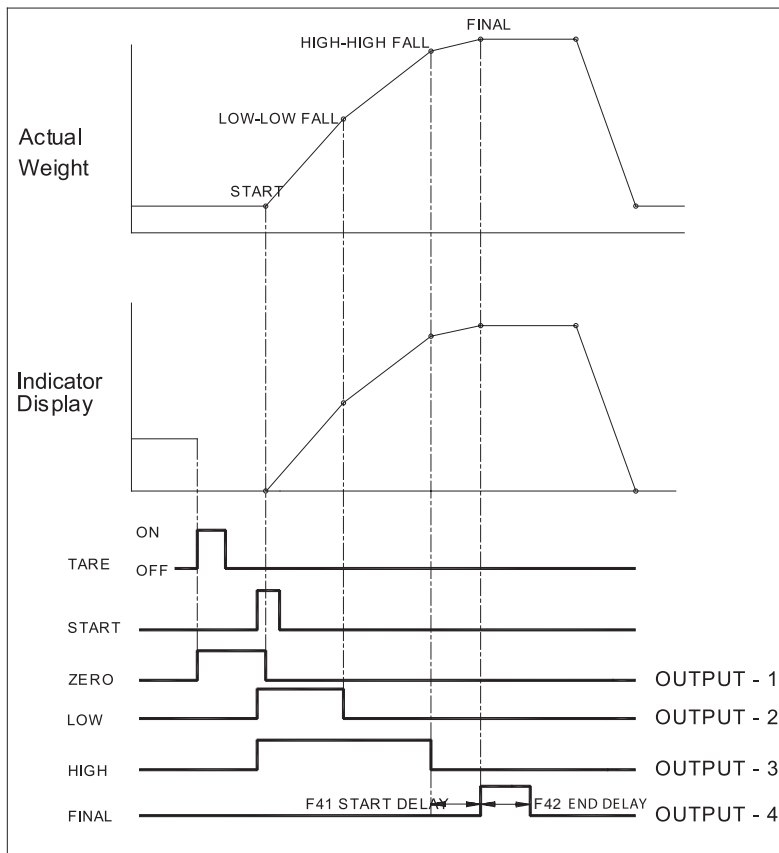

F41 (Except CI-5010A)

FUNCTION : Start delay time of finish relay			
	VF DISPLAY	SUB VFD	DESCRIPTION
Set value (0.0 ~ 9.9)	0.0	F41 dELAY1	No delay
	1.3		Delay for 1.3 sec
	5.5		Delay for 5.5 sec

F42 (Except CI-5010A)

FUNCTION : End delay time of finish relay			
Set value (0.0~9.9)	VF DISPLAY	SUB VFD	DESCRIPTION
	0.0	F42 dELAY2	No delay
	1.3		Delay for 1.3 sec
	5.5		Delay for 5.5 sec

F43 (Except CI-5010A)

FUNCTION : Range of zero relay			
Set value (00~99)	VF DISPLAY	SUB VFD	DESCRIPTION
	0	F43 ZrELAY	Relay is ON at zero
	3		Relay IS ON within 3 division

F44

FUNCTION : Select of external key						
Set value (0~6)	VF DISPLAY	SUB VFD	DESCRIPTION			
			KEY INPUT 1	KEY INPUT 2	KEY INPUT 3	KEY INPUT 4
	0	F44 SELECT	ZERO	TARE	NET	GROSS
	1		ZERO	TARE	PRINT	GROSS/NET
	2		ZERO	TARE	HOLD	HOLD CANCEL
	3		ZERO	TARE	START	STOP
	4		ZERO	PRINT	START	STOP
	5		TARE CANCEL	TARE	START	STOP
6	GROSS		NET	START	STOP	

Note 1. START & STOP keys are not possible for CI-5010A.

F45

FUNCTION : Select of Option			
	VF DISPLAY	SUB VFD	DESCRIPTION
Set value (0~2)	0	F45 oPtion	No option
	1		BCD OUT
	2		Analog option (Vout : 0 - 10V, Iout : 0 - 24mA)

F46

FUNCTION : Output current at zero			
	VF DISPLAY	SUB VFD	DESCRIPTION
Set value (0~24000)	00000	F46 ZERo	0 mA
	4000		4.000 mA

Note 1. When the verification interval includes the values under the decimal point, input the digit values under the decimal point by using  key. In the case that the verification interval is 0.5kg -> it can have the zero output 4.000mA after the value 400.0 is input.

F47

FUNCTION : Output current at maximum capacity of the scale			
	VF DISPLAY	SUB VFD	DESCRIPTION
Set value (0~24000)	00000	F47 HlgH	0 mA
	20000		20.000 mA

Note 1. When the verification interval includes the values under the decimal point, input the digit values under the decimal point by using  key. In the case that the verification interval is 0.5kg -> it can have the maximum output 20.000mA after the value 2000.0 is input.

F48



FUNCTION : Analog output data			
	VF DISPLAY	SUB VFD	DESCRIPTION
Set value (0,1)	0	F48 n-9	Net data
	1		Gross data

F49

FUNCTION : Logic of BCD data			
	VF DISPLAY	SUB VFD	DESCRIPTION
Set value (0,1)	0	F49 LoGIC	Positive Logic
	1		Negative Logic

12. Weighing Mode







(1) Zero Compensation

	VF Display and use key	Platform	Description
Step 1		Empty	Small variations in the scale's zero
Step 2			
Step 3		Empty	Remove small variations in the scale's zero.

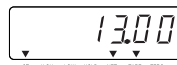
Note 1. Set zero range to $\pm 2\%$ or $\pm 10\%$ of maximum capacity in F09. (See page 34.)

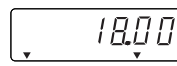
Note 2. Set the conditions of zero in F10. (See page 34.)

(2) Net/Gross weight.

	VF Display and use key	Platform	Description
Step 1		Container and item	An item weight: 13.00 kg Tare weight : 5.00 kg Net weight is shown on the display.
Step 2	 Press the  key.		
Step 3		Container and item	Gross weight is shown on the display now.
Step 4	 Press the  key.		
Step 5		Container and item	Net weight is on the display now.













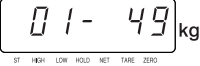
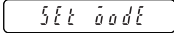

Note. NET lamp is on when net weight is shown on the display.

NET lamp is off when gross weight is shown on the display.

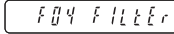



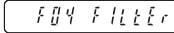

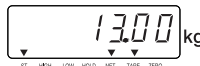





To release tare, press  key when the platform is empty.

Tare should be greater than the zero range of F09 in SET mode.

(3) Change of digital filter.

	VF Display and use key	Platform	Description
Step 1		Item	Weighing mode
Step 2	 Press the  key for 3 seconds.		You can go to SET mode
Step 3	 	Item	SET mode
Step 4	 Press the  ,  , or  ,  key		SET Menu 4
Step 5	 		Current value of F04 is 5. "5" : 5 times average
Step 6	 Press the  or  key		Change "5" to "9". "9" : 9 times average
Step 7	 		
Step 8	 Press the  key two times.		Save & Exit
Step 9		Item	Return to Weighing mode

(4) How to save ID code

	VF Display and use key	Platform	Description
Step 1		Empty	
Step 2		Put item (iron)	
Step 3	 Press the  key		
Step 4			
Step 5	  		ID code of "iron"
Step 6		item (iron)	
Step 7	 		Save ID
Step 8		item (iron)	Go to the weighing mode.

Note. The range of ID code is 0~50.

(5) How to enter high limit value (Except CI-5010A)

	VF Display and use key	Platform	Description
Step 1		Empty	
Step2	Press the key		The display shows previous high limit value.
Step 3	Press , , , and keys.		Enter high limit value(500.0kg)
Step 4	Press the key		Save
Step 5		Empty	High limit value is saved and sub display shows 500.0kg.

Note. In case that a number with decimal point is input, use the key.
 High limit value should be greater than the low limit value.

(6) How to enter high fall limit value (Except CI-5010A)

	VF Display and use key	Platform	Description
Step 1		Empty	The sub display shows high limit value. (500.0kg)
Step2			The display shows previous high_fall limit value.
Step 3			Enter high_fall limit value(5.2kg)
Step 4			
Step 5		Empty	High_fall limit value is saved.

Note. If you want to enter decimal point, press the key.











(7) How to clear ID data

	VF Display and use key	Platform	Description
Step 1		Empty (or item)	
Step2	Press the for 3 seconds.		
Step 3		Empty (or item)	All data of id (0~50) is cleared.

Note. Even though there is an item on the platter, data clearing is performed.

(8) How to print subtotal.

Assume that the current ID code is 10.

	VF Display and use key	Platform	Description
Step1	 Press the  key.		
Step2	 Press the  and  key.		Enter ID code "10".
Step3	 Press the  key.		
Step 4	 Press the  and  key.		Sub total is printed.

Note. If printing is done, the total weight and count of this ID number is set to 0.
The print form is as follows.

SUB TOTAL	



DATE :	2001.10.13
TIME :	09:30
ID :	10
COUNT :	5
TOTAL :	350.0kg

Standard format

S-TOTAL :	350.0kg

Format of F31-6

(9) How to print grand total

	VF Display and use key	Platform	Description
Step 1	  , 		Grand total printing

Note. Grand total means the total weight of all ID cord.
The print form is as follows.

OVERALL-TOTAL	

DATE :	2001.10.13
TIME :	16:30
COUNT :	5
TOTAL :	750.0kg

Standard format

TOTAL :	350.0kg

Format of F31-6

13. Options

OP - 1	RS-422 Serial Interface
--------	-------------------------

- Transmission mode : Same as RS-232C interface
- Signal format : Same as RS-232C
- Data format : Same as RS-232C
- Connecting method of RS-422 port

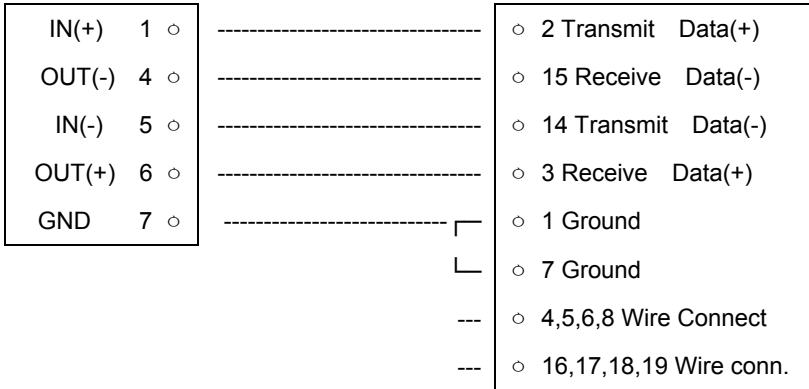

9 pin port (Female)
RS-422 port of CI-5000 Series

25 pin port (Female)
Serial port of computer

OP - 2	BCD Output Interface
--------	----------------------

Parallel BCD output is the interface that transmits the weight as BCD code.
 Inner circuit of input/output circuit is electronically disconnected by photo-coupler.

■ Connection of pins

PIN	SIGNAL	PIN	SIGNAL
1	Ground (GND)	26	High : Net, Low : Gross
2	1×10^0	27	N.C.
3	2×10^0	28	N.C.
4	4×10^0	29	N.C.
5	8×10^0	30	N.C.
6	1×10^1	31	N.C.
7	2×10^1	32	N.C.
8	4×10^1	33	N.C.
9	8×10^1	34	N.C.
10	1×10^2	35	N.C.
11	2×10^2	36	N.C.
12	4×10^2	37	External Vcc
13	8×10^2	38	N.C.
14	1×10^3	39	External Vcc
15	2×10^3	40	N.C.
16	4×10^3	41	N.C.
17	8×10^3	42	High : +, Low : -
18	1×10^4	43	Decimal point : 10^1
19	2×10^4	44	Decimal point : 10^2
20	4×10^4	45	Decimal point : 10^3
21	8×10^4	46	Over Load
22	1×10^5	47	N.C.
23	2×10^5	48	N.C.
24	4×10^5	49	Busy
25	8×10^5	50	N.C.

- 50 pin connector : CHAMP 57-40500(Amphenol) (Female)
- TTL Open-Collector Output
- SIGNAL LOGIC

1. BCD data output : Positive, Negative logic
2. Polarity output : “+” = High
3. OVER output : “OVER” = High
4. BUSY output : “BUSY” = High

■ Standard Accessory : Mating connector 57-30500(Amphelol) Male 1EA.

■ Weight Data

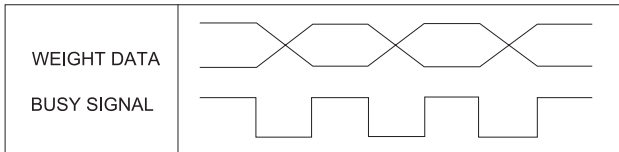

■ BCD output circuit

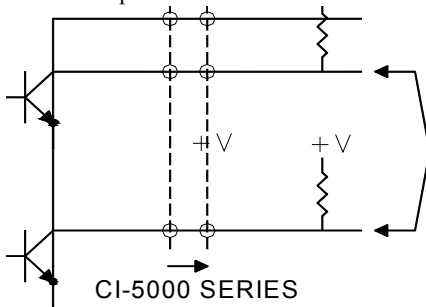

Voltage	30V max.
Current	30mA max.
Output Voltage when ON	0.2V Txp

■ BCD output circuit is Open Collector Type.

(1) Current output

■ Specification

Output Current	Max. 0~24 mA
Resolutions	Over 1/1000
Temperature Coefficient	0.01%/°C
Max. Load Impedance	500Ω MAX.

■ How to set switch

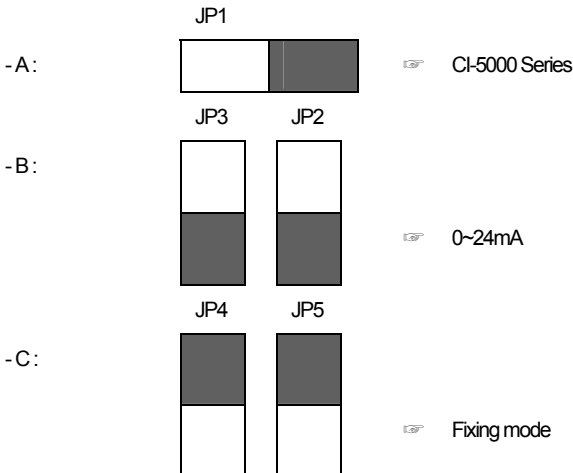
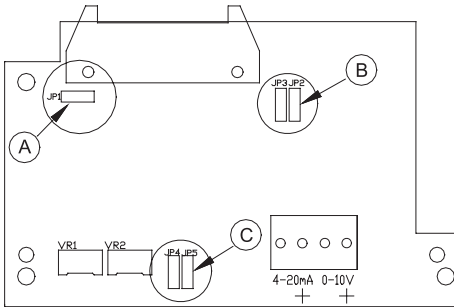

■ Setting output current

You can set output current in F46 and F47 of Set mode.

The setting range is 0.000 mA to 24.000 mA, by steps of 0.001 mA.

- Max. capacity : 100 kg, Min. capacity : 0.05 kg

case ① F46 : 4000, F47 : 20000

case ② F46 : 20000, F47 : 4000

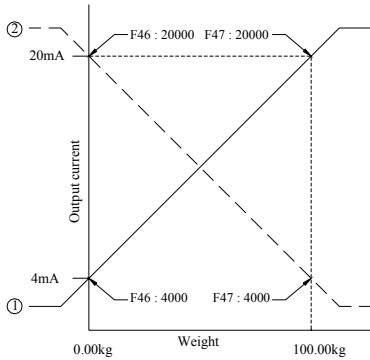

■ How to use current to voltage

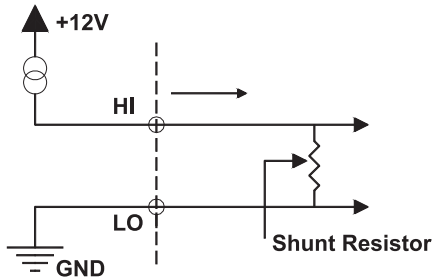

If F46 is set to 4mA, F47 is set to 20mA in SET mode and resistor is 250Ω, the output will be 1V ~ 5V.

Note. You have to use high capacity of resistor. If you add resistor 500Ω,

$$W=I^2R=(0.02)^2 \times 500 = 0.2W$$

Therefore, you have to use 1/2W or more capacity and low temperature coefficient resistor.

(2) Voltage output

■ Specification

Output voltage	0 ~ 10V
Resolution	over 1/1000
Temperature coefficient	0.01%/°C

■ How to set switch

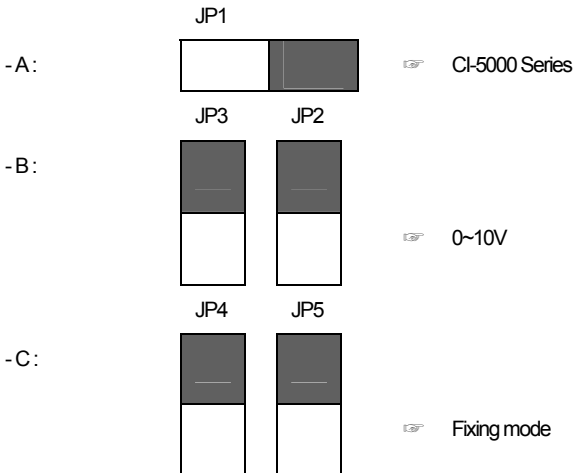
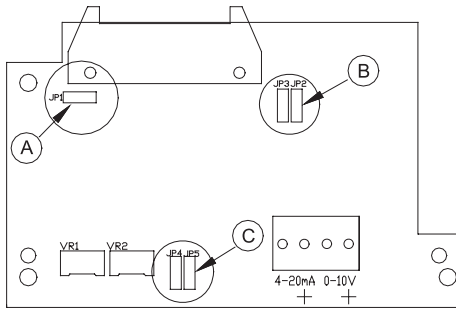

- When the weight is 0, output voltage is 0V.
When the weight is maximum capacity is the scale, output voltage is 10V.

■ Setting of Set mode

- ① F45 : 2 ② F46 : 0 ③ F47 : 0

14. Sealing Method

① Rear panel sealing

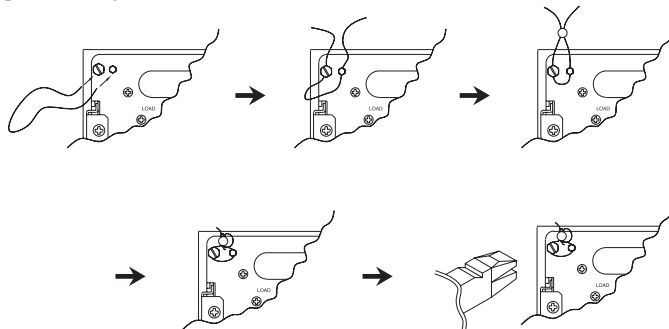

② Load cell connector sealing

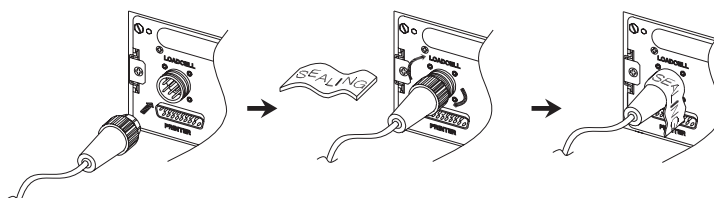

15. Error Messages & Troubleshooting

(1) Weighing mode

CH 01

- Reason
Internal RAM is erased.
- ☞ Troubleshooting
Please call your CAS dealer.

CH 02

- Reason
Load cell connection failure or error in A/D conversion part.
- ☞ Troubleshooting
Please call your CAS dealer.

CH 03

- Reason
The zero range exceeds $\pm 10\%$ of maximum capacity.
- ☞ Troubleshooting
Check that there is nothing on the platform.

CH 04

- Reason
You pressed any key for long time or there is a problem in key part.
- ☞ Trouble-shooting
If there is no problem in key part, call your CAS dealer.

CH 05

- Reason
Failure of print connection.
- ☞ Troubleshooting
Check the connection between Indicator & Printer.

Over

- Reason
The display weight is greater than the maximum capacity that you have set.
- ☞ Troubleshooting
The weight of item is greater than the max. capacity on the platform.
This may damage Load Cell.

(2) CAL mode

CH 11

■ Reason

The resolution exceeds the 1/10,000.

☞ Troubleshooting

Lower the resolution. Change the maximum capacity in CAL1 or change the division in CAL2 so that the resolution should be below 1/10,000.

CH 12

■ Reason

The weight for span calibration is lower than 10%, or greater than 100% of the maximum capacity of the scale.

☞ Troubleshooting

The weight for span calibration should be within 10%~100% of the maximum capacity of the scale in CAL3.

CH 13

■ Reason

Load cell output is too small or large at span calibration.

☞ Troubleshooting

Calibrate with lower resolution.

CH 14

■ Reason

Load cell output is too small or large at zero calibration.

☞ Troubleshooting

Check whether the platform is empty.

Calibrate again after checking in A/D TEST mode.

MEMO



MEMO

MEMO





MEMO

MEMO





MEMO



CI-5010A/CI-5200A/CI-5500A

Weighing Indicator



CAS BLDG., # 440-1, SUNGNAE-DONG,
GANGDONG-GU, SEOUL, KOREA
TEL_ 82 2 2225 3500
FAX_ 82 2 475 4668
www.globalcas.com